

22260661	<b>DATA SHEET</b>	
Valid from: 12.09.2019	<b>AB-C3-(L*)PVC-M12FA</b>	

## Product description

Sensor/actuator cable, 3-pos., PVC black, free conductor end on angled socket M12.



## Product variations

Article number	Article description	Length (L*) [m]
22260661	AB-C3-5,0PVC-M12FA	5
22262083	AB-C3-10,0PVC-M12FA	10
22262095	AB-C3-2,0PVC-M12FA	2

This datasheet is also valid for other length configurations. Other lengths upon request.

## M12 connector

### General properties

Coding	A
Protection degree	IP65/IP67/IP68
Number of contacts	3
Ambient temperature	-25 °C to +90 °C (-13 °F to +194 °F)
Rated voltage	250 V
Rated current	4 A
Insulation resistance	≥ 100 MΩ
Contact resistance	≤ 5 mΩ
Overvoltage category	III
Pollution degree	3
Tightening torque	0.4 Nm
Mating cycles	100

### Materials

Contact carrier	TPU GF
Contact carrier, Inflammability class acc. to UL 94	HB
Material, contacts	CuSn
Contact surface	Ni/Au
Material, grip body	TPU
Material, knurl	zinc die-cast, nickel-plated
Material, sealing	NBR

Creator: MANA2/PDP Released: IVSE1/PDP	Document: DB22260661EN Version: 03	Page 1 of 4
---	---------------------------------------	-------------

22260661	<b>DATA SHEET</b>	
Valid from: 12.09.2019	<b>AB-C3-(L*)PVC-M12FA</b>	

## Cable

Signal line, construction	19 x 0.15 mm
Signal line, AWG	22
Conductor, material	stranded of bare copper wire
Conductor, cross-section	0.34 mm <sup>2</sup>
Number of cores	3
Core identification code	brown (1), blue (3), black (4)
Outer diameter, core insulation	1.26 mm
Core insulation, material	PVC
Outer sheath	PVC
Outer sheath, colour	black similar to RAL 9005
Outer diameter, cable	4.3 mm
Ambient temperature, fixed installation	-40 °C to +80 °C (-40 °F to +176 °F)
Ambient temperature, flexing	-25 °C to +80 °C (-13 °F to +176 °F)
Minimum bending radius, fixed installation	5 x cable diameter
Minimum bending radius, flexing	10 x cable diameter
Nominal voltage	≤ 300 V
Test voltage	≥ 2500 V
Flame retardance	flame retardant acc. to UL-Style 2464

## Standards/Approvals

Product standard, M12 connector	IEC 61076-2-101
UL-listed, E-File	E249137

Creator: MANA2/PDP Released: IVSE1/PDP	Document: DB22260661EN Version: 03	Page 2 of 4
---	---------------------------------------	-------------

22260661	<b>DATA SHEET</b>	
Valid from: 12.09.2019	AB-C3-(L*)PVC-M12FA	

## Drawings

Dimensioned drawing, M12 connector

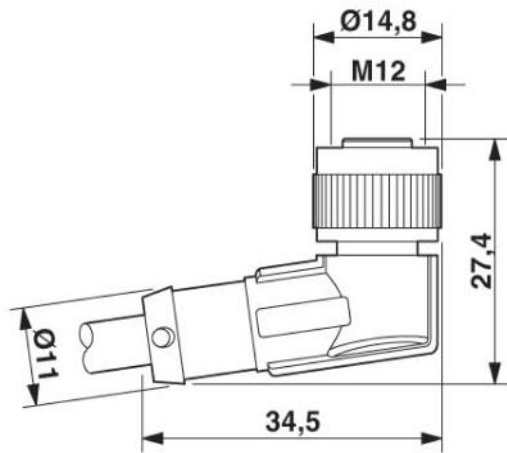

Wiring diagram

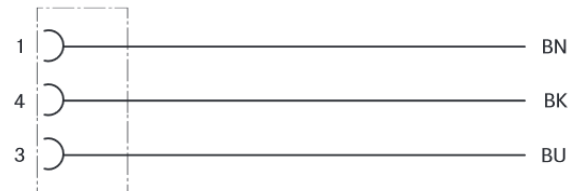

Pin assignment

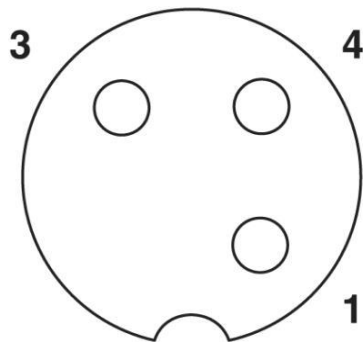

Cable

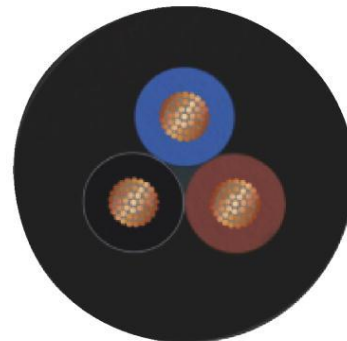

Core identification code: brown (1), blue (3), black (4)

## Application range

Automation, industrial machinery and plant engineering

## Note

Photographs are not true to scale and do not represent detailed images of the respective products.

Creator: MANA2/PDP Released: IVSE1/PDP	Document: DB22260661EN Version: 03	Page 3 of 4
---	---------------------------------------	-------------

22260661	<b>DATA SHEET</b>	
Valid from: 12.09.2019	<b>AB-C3-(L*)PVC-M12FA</b>	

Creator: MANA2/PDP Released: IVSE1/PDP	Document: DB22260661EN Version: 03	Page 4 of 4
---	---------------------------------------	-------------