

22260344	<b>DATA SHEET</b>	
Valid from: 12.09.2019	<b>AB-C4-(L*)PUR-M12FS-2L</b>	

## Product description

Sensor/actuator cable, 4-pos., PUR black, straight socket M12 on free conductor end, 2 LEDs.



## Product variations

Article number	Article description	Length (L*) [m]
22260344	AB-C4-2,0PUR-M12FS-2L	2
22260345	AB-C4-5,0PUR-M12FS-2L	5
22260346	AB-C4-10,0PUR-M12FS-2L	10
22260911	AB-C4-15,0PUR-M12FS-2L	15

This datasheet is also valid for other length configurations. Other lengths upon request.

## M12 connector

### General properties

Coding	A
Protection degree	IP65/IP67/IP68
Number of contacts	4
Ambient temperature	-25 °C to +90 °C
Rated voltage	24 V
Rated current	4 A
Insulation resistance	≥ 100 MΩ
Contact resistance	≤ 5 mΩ
Overvoltage category	II
Pollution degree	3
Tightening torque	0.4 Nm
Mating cycles	100

### Materials

Contact carrier	TPU GF
Contact carrier, inflammability class in accordance with UL 94	HB
Material, contacts	CuSn
Contact surface	Ni/Au
Material, grip body	TPU
Material, knurl	zinc die-cast, nickel-plated
Material, sealing	NBR

Creator: MANA2/PDP Released: IVSE1/PDP	Document: DB22260344EN Version: 05	Page 1 of 3
---	---------------------------------------	-------------

22260344	<b>DATA SHEET</b>	
Valid from: 12.09.2019	<b>AB-C4-(L*)PUR-M12FS-2L</b>	

## Cable

Signal line, construction	42 x 0.10 mm
Signal line, AWG	22
Conductor, material	stranded of bare copper wire
Conductor, cross-section	0.34 mm <sup>2</sup>
Number of cores	4
Core identification code	brown (1), white (2), blue (3), black (4)
Outer diameter, core insulation	1.27 mm
Core insulation, material	PP
Outer sheath	PUR
Outer sheath, color	grey-black similar to RAL 7021
Outer diameter, cable	4.7 mm
Ambient temperature, fixed installation	-40 °C to +80 °C
Ambient temperature, flexing	-25 °C to +80 °C
Minimum bending radius, fixed installation	5 x cable diameter
Minimum bending radius, flexing	10 x cable diameter
Travel length	10 m
Travel speed	3 m/s
Number of bending cycles	4.000.000
Nominal voltage	≤ 300 V
Test voltage	≥ 3000 V
Flame retardance	flame retardant acc. to UL 758/1581 (horizontal) UL 758/1581 FT2
Halogen free	halogen free acc. to DIN VDE 0472 Part 815 DIN EN 50267-2-1
Oil resistance	oil resistant acc. to DIN EN 60811-2-1 resistant to hydrolysis and microbes good resistant to acids, lyes and solvents
Other resistances	resistant to sea water limited UV resistance acc. to DIN EN ISO 4892-2-A low-adhesion abrasion-resistant

## Standards/Approvals

Product standard, M12 connector	IEC 61076-2-101
UL-listed, E-File	E249137

Creator: MANA2/PDP Released: IVSE1/PDP	Document: DB22260344EN Version: 05	Page 2 of 3
---	---------------------------------------	-------------

22260344	<b>DATA SHEET</b>	
Valid from: 12.09.2019	AB-C4-(L*)PUR-M12FS-2L	

## Drawings

Dimensioned drawing, M12 connector

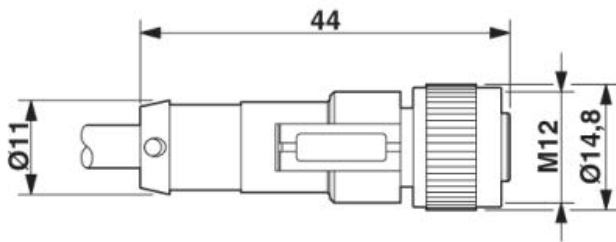

Wiring diagram

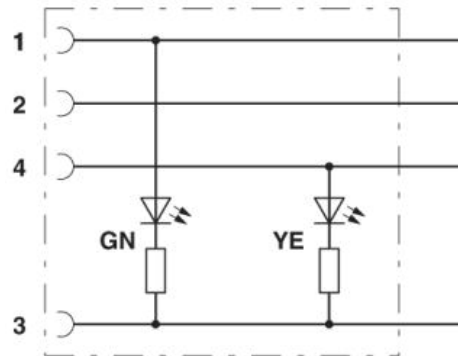

Pin assignment

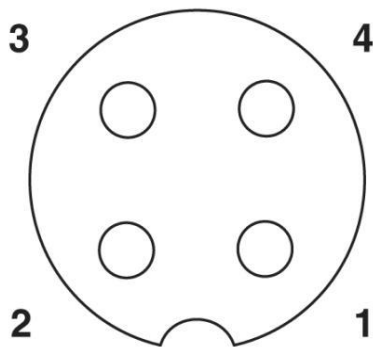

Cable

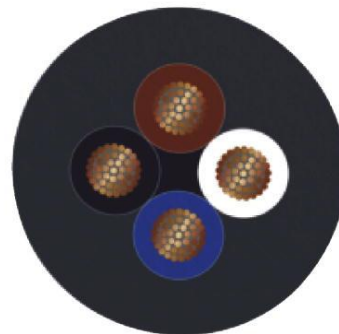

Core identification code: brown (1), white (2), blue (3), black (4)

## Application range

Automation, industrial machinery and plant engineering

## Note

Photographs are not true to scale and do not represent detailed images of the respective products.

Creator: MANA2/PDP Released: IVSE1/PDP	Document: DB22260344EN Version: 05	Page 3 of 3
---	---------------------------------------	-------------