

22260056	DATA SHEET	
Valid from: 12.09.2019	AB-C4-M8MA-(L*)PUR	

Product description

Sensor/Actuator cable, 4-pos., PUR black, angled plug
M8 on free conductor end.



Product variations

Article number	Article description	Length (L*) [m]
22260056	AB-C4-M8MA-2,0PUR	2
22260057	AB-C4-M8MA-5,0PUR	5
22260058	AB-C4-M8MA-10,0PUR	10

This datasheet is also valid for other length configurations. Other lengths upon request.

M8 connector

General properties

Coding	A
Protection degree	IP65/IP67/IP68
Number of contacts	4
Ambient temperature	-25 °C to +90 °C (-13 °F to +194 °F)
Rated voltage	30 V
Rated current	4 A
Insulation resistance	≥ 100 MΩ
Contact resistance	≤ 5 mΩ
Overvoltage category	II
Pollution degree	3
Tightening torque	0.2 Nm
Mating cycles	100

Materials

Contact carrier	TPU GF
Contact carrier, inflammability class acc. to UL 94	HB
Material, contacts	CuSn
Contact surface	Ni/Au
Material, grip body	TPU
Material, knurl	zinc die-cast, nickel-plated
Material, sealing	NBR

Creator: MANA2/PDP Released: IVSE1/PDP	Document: DB22260056EN Version: 03	Page 1 of 3
---	---------------------------------------	-------------

22260056	DATA SHEET	
Valid from: 12.09.2019	AB-C4-M8MA-(L*)PUR	

Cable

Signal line, construction	32 x 0.10 mm
Signal line, AWG	24
Conductor, material	stranded of bare copper wire
Conductor, cross section	0.25 mm ²
Number of cores	4
Core identification code	brown (1), white (2), blue (3), black (4)
Outer diameter, core insulation	1.17 mm
Core insulation, material	PP
Outer sheath	PUR
Outer sheath, color	black similar to RAL 9005
Outer diameter, cable	3.9 mm
Ambient temperature, fixed installation	-40 °C to +80 °C (-40 °F to +176 °F)
Ambient temperature, flexing	-25 °C to +80 °C (-13 °F to +176 °F)
Minimum bending radius, fixed installation	5 x cable diameter
Minimum bending radius, flexing	10 x cable diameter
Travel length	10 m
Travel speed	3 m/s
Acceleration	10 m/s ²
Number of bending cycles	4.000.000
Nominal voltage	≤ 300 V
Test voltage	≥ 3000 V
Flame retardance	flame retardant acc. to UL-Style 20549
Halogen free	halogen free acc. to DIN VDE 0472 Part 815
Oil resistance	oil resistant acc. to DIN EN 60811-2-1 resistant to hydrolysis and microbes
Other resistances	good resistant to acids, lyes and solvents resistant to sea water limited UV resistance acc. to DIN EN ISO 4892-2-A

Standards/Approvals

Product standard, M8 connector	IEC 61076-2-104
UL-listed, E-File	E249137

Creator: MANA2/PDP Released: IVSE1/PDP	Document: DB22260056EN Version: 03	Page 2 of 3
---	---------------------------------------	-------------

22260056	DATA SHEET	
Valid from: 12.09.2019	AB-C4-M8MA-(L*)PUR	

Drawings

Dimensioned drawing, M8 connector

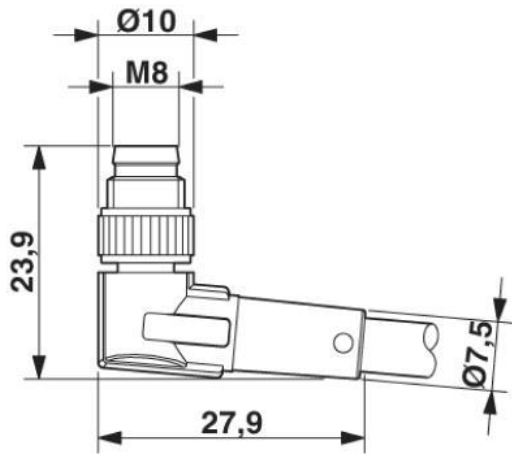

Wiring diagram

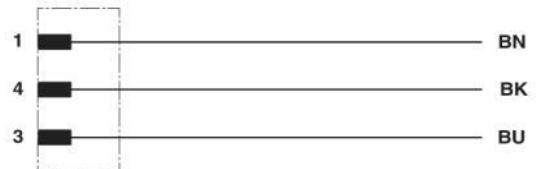

Pin assignment

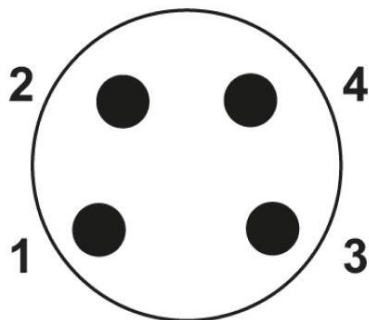

Cable

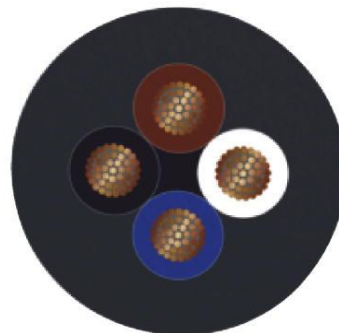

Core identification code: brown (1), white (2), blue (3), black (4)

Application range

For increased mechanical stress and harsh operating conditions

Note

Photographs are not true to scale and do not represent detailed images of the respective products.

Creator: MANA2/PDP Released: IVSE1/PDP	Document: DB22260056EN Version: 03	Page 3 of 3
---	---------------------------------------	-------------