

Quick Start Guide

PROFINET switch 8 port, IP67

Version

1_{en}



Content

3

1. Safety instructions	4
1.1 Target audience	4
1.2 Intended use	4
1.3 Operation	4
1.4 Security	4
2. Introduction	5
3. Preparing the PROFINET switch	6
3.1 Connecting	6
3.2 Connection layout M12	7
4. Setup and Use	8
4.1 Install GSDML file	8
4.2 Setup in the hardware-configuration	9
4.3 Setting the port properties	10
4.4 Topology detection	12
4.5 Media Redundancy Protocol (MRP)	14
4.6 Assign the PROFINET switch a name	16
4.7 Further configuration and diagnosis via the web interface	17
5. Diagnosis via LEDs	18
6. Technical data	19

1. Safety instructions



CAUTION

1.1 Target audience

This description is only intended for trained personnel qualified in control and automation engineering who are familiar with the applicable national standards.

For installation, commissioning, and operation of the components, compliance with the instructions and explanations in this operating manual is essential. The specialist personnel is to ensure that the application or the use of the products described fulfills all safety requirements, including all applicable laws, regulations, provisions, and standards.



WARNING

1.2 Intended use

The consequences of improper use may include personal injury to the user or third parties, as well as property damage to the control system, the product, or the environment. Use the device only as intended!.



ATTENTION

1.3 Operation

Successful and safe operation of the device requires proper transport, storage, setup, assembly, installation, commissioning, operation, and maintenance. Operate the device only in flawless condition. The permissible operating conditions and performance limits (technical data) must be adhered to. Retrofits, changes, or modifications to the device are strictly forbidden.



ATTENTION

1.4 Security

The device is a network infrastructure component and therefore an important element in the security consideration of a plant. When using the device, therefore, observe the relevant recommendations to prevent unauthorized access to installations and systems. Further information on this can be found in the device manual.

2. Introduction



NOTE

Please consider the safety instructions for the product, which can be found in the PROFINET switch manual. You can download the manual from the website www.lappkabel.com/activenetworkcomponents in the download area of the product or use the shown QR code.



This document is intended to explain the initial commissioning of the PROFINET switch in a standard application case.

3. Preparing the PROFINET switch

3.1 Connecting

The PROFINET switch must be supplied with 24 VDC at the wide range input 18 - 30 VDC via the M12 connector (X2).

The connection (FE) is for the functional earth. Connect it properly to the reference potential.

The M12 sockets „P1 - P8“ (X1) are used to connect the network nodes (PROFINET or Ethernet).

The inputs D1 and D2 do not yet have a function in the current firmware version and will be available for possible additional functions in a later firmware version.

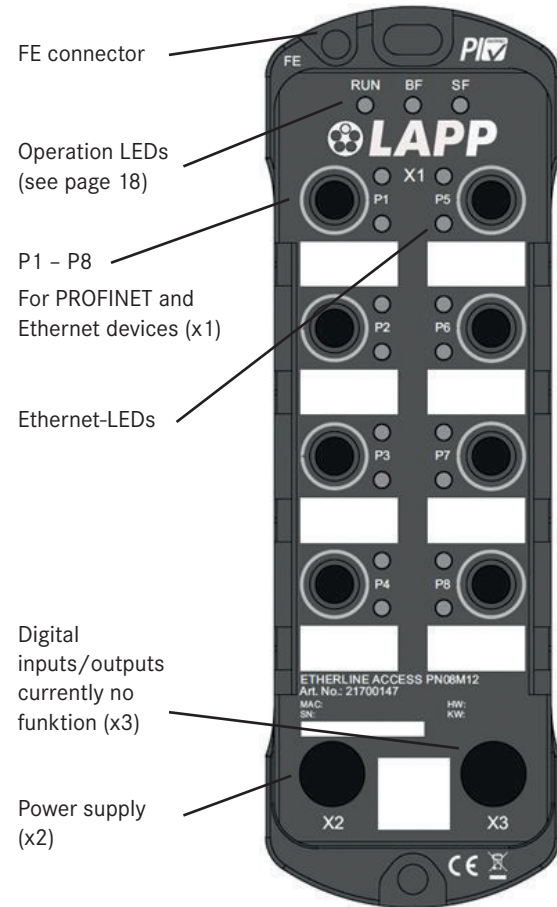

3.2 Connection layout M12

X1, M12 D-coded PROFINET connector:

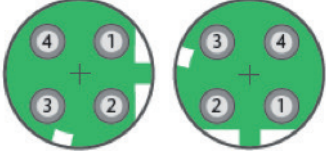
	Pin 1	TX-P
	Pin 2	RX-P
	Pin 3	TX-N
	Pin 4	RX-N

X2, M12 L-coded power connector:

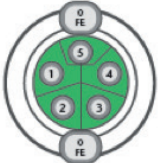
	Pin 1	24VDC in
	Pin 2, 4	not connected
	Pin 3	GND
	Pin 5	FE

X3, M12 A-coded I/O connector:

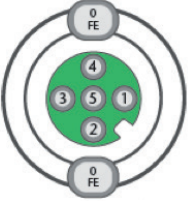
	Pin 1	24VDC out
	Pin 2	D1 Input Type 3 EN 61131-2, output 24VDC 500mA electronic fuse
	Pin 3	GND
	Pin 4	D2 Input Type 3 EN 61131-2, output 24VDC 500mA electronic fuse
	Pin 5	FE

4. Setup and use

4.1 Install GSDML file

You can download the GSDML file from the website www.lappkabel.com/activenetworkcomponents in the download area of the product or use the shown QR code.

Install the GSDML file in the TIA Portal menu “Options” / “Manage general station description files (GSD)”.

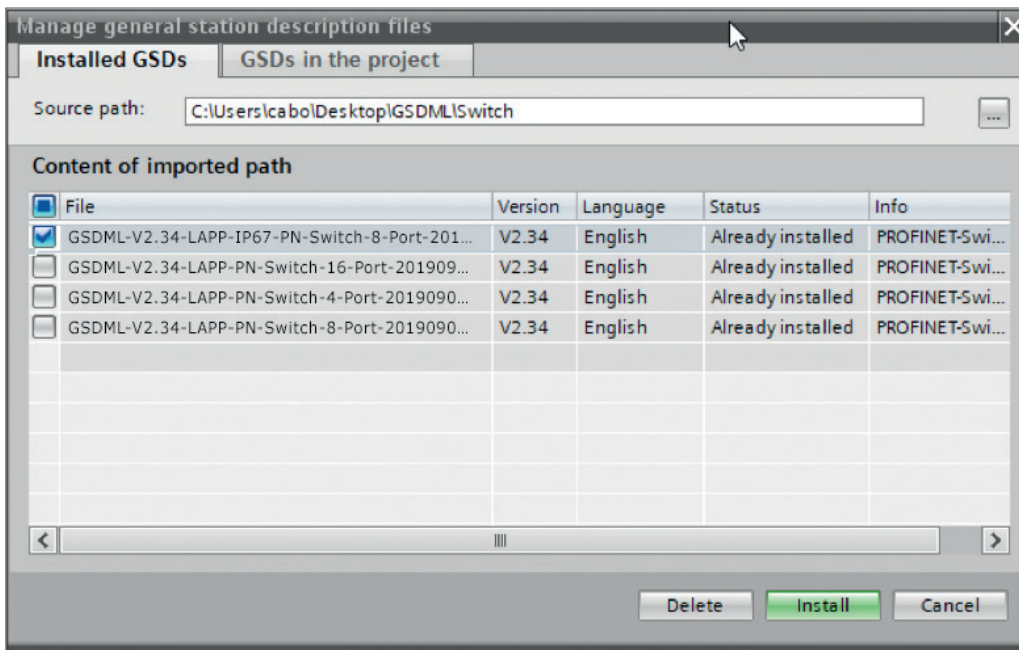

4.2 Setup in the hardware-configuration

Following installation, the PROFINET switch can be found in the hardware catalog under “Other field devices -> PROFINET IO -> Network Components -> U. I. Lapp GmbH & Co. KG -> U. I. Lapp PN-Switch”. Add the “PROFINET-Switch, 8-port, IP67” device to the project and connect it with your PROFINET network.

By calling up the device properties, you must assign the PROFINET switch a unique PROFINET name in the project and check the IP address for plausibility.

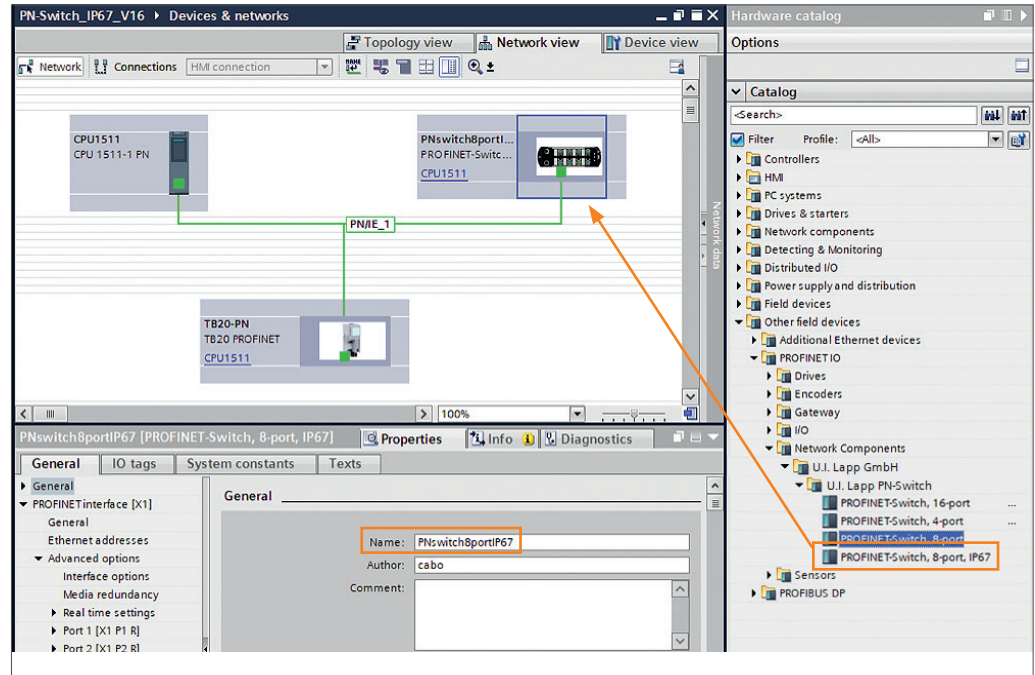

The real device must later be assigned the same name as in the project.

4.3 Setting the port properties

Each port of the PROFINET switch can be individually configured.

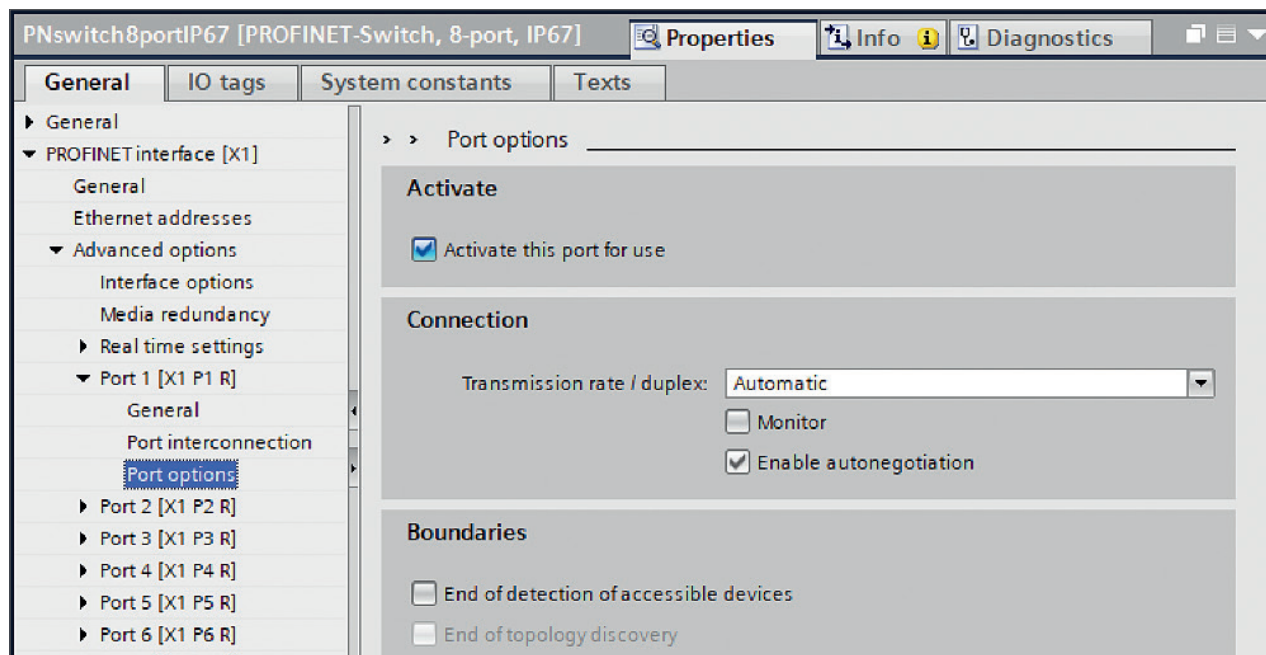

“Activate this port for use”	The port can be switched off here. This option is recommended when the port should not be used. Unauthorized trespass into the network is prevented.
Transmission rate / duplex: “Automatic”	The port synchronizes itself automatically with the communication partner (auto-negotiation).
Transmission rate / duplex: “TP 100 Mbps full duplex”	Fixed specification of the transmission rate. This option is recommended when connecting PROFINET IO devices.
Monitor	Send a diagnosis by Link Down
Enable autonegotiation	Automatic recognition of the transmission speed and the cable type (cross or patch cable)
End of detection of accessible devices	The DCP telegrams for recording accessible devices are not forwarded from this port. Subscribers behind this port are no longer displayed under "Accessible subscribers" in the topology. Users behind this port can no longer be reached by the CPU.
End of topology discovery	LLDP frames for topology discovery are not forwarded on this port.

4.4 Topology detection

The PROFINET switch supports the mechanisms for neighborhood detection (LLDP). With this function it is possible to detect the topology of a PROFINET network, or to specify it for purposes of checking for the correct structuring by the configuration.

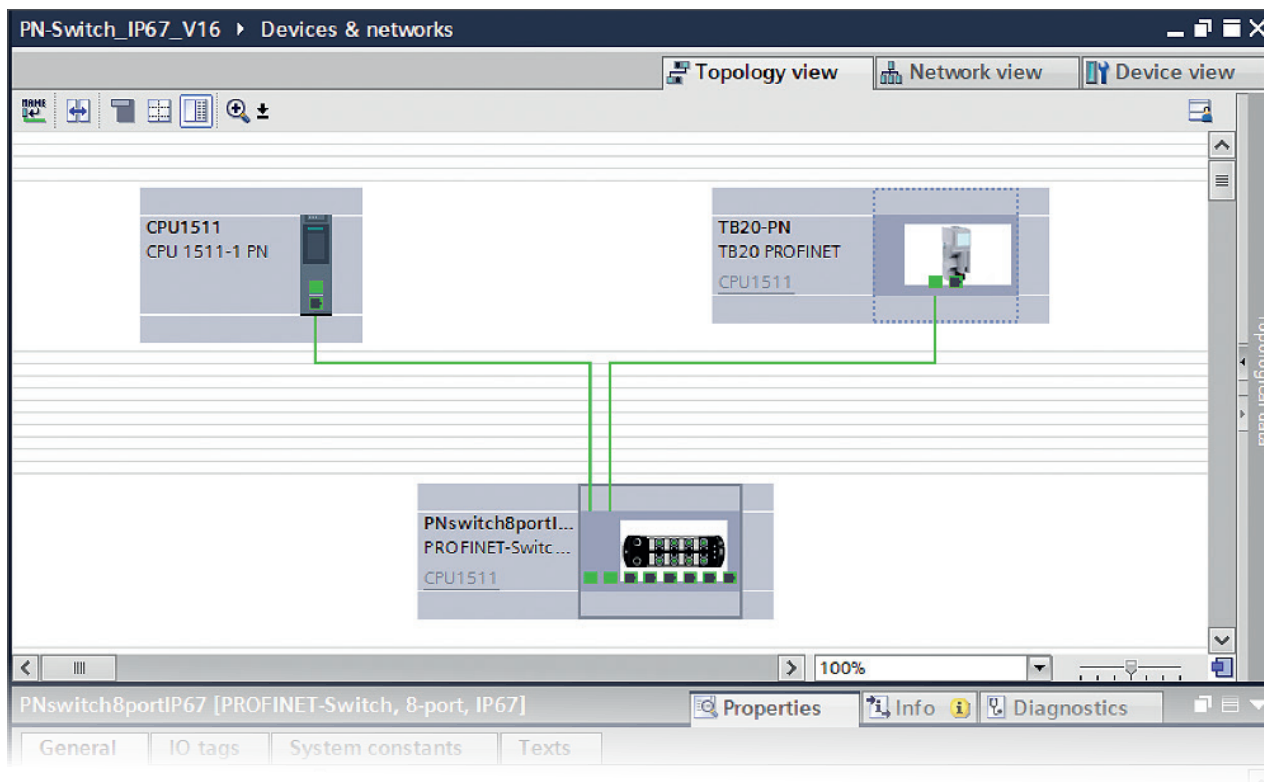

If the topology was prescribed in the configuration, neighboring devices can also be assigned the PROFINET name in the event of the replacement of a device. This makes the recognition and testing of the network topology and the “device exchange in operation” of connected PROFINET participants possible.

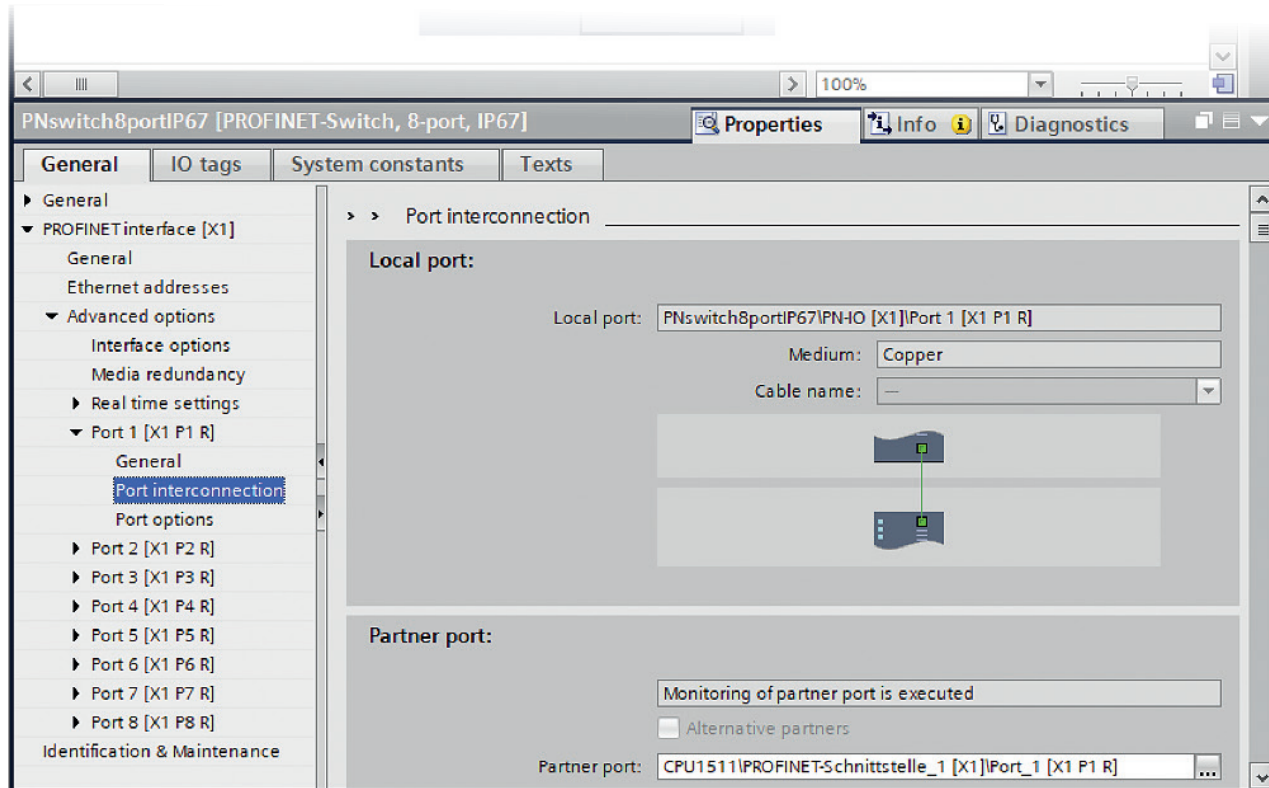

4.5 Media Redundancy Protocol (MRP)

The PROFINET switch supports the optional media redundancy protocol (MRP) as MRP client. MRP stands for “media redundancy protocol”. MRP enables ring wiring, which also makes operation of the PROFINET network possible in the event of the failure of a cable or of a participant.

There must be at least one MRP master (e.g. the CPU) in an MRP ring. All other participants of the ring are then MRP clients.

In order to assign the PROFINET switch to an MRP ring, the “MRP domain” must be set at slot X1 for the option “Media redundancy role” and the role set to “Client”.

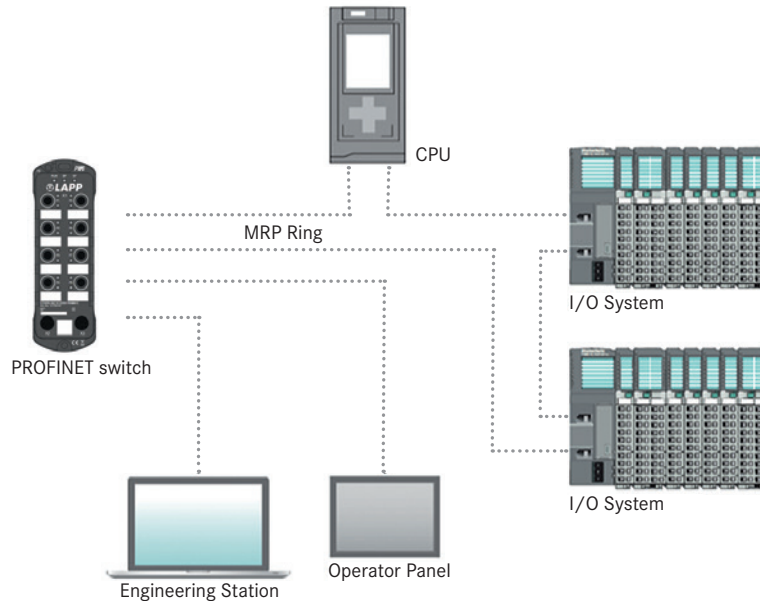

The screenshot displays the SIMATIC Manager interface. The top window shows a network topology with three main components: a CPU1511 (CPU 1511-1 PN), a TB20-PN (TB20 PROFINET CPU1511), and a PNswitch8portI... (PROFINET-Switch, 8-port, CPU1511). Green lines represent network connections between these devices.

The bottom window shows the configuration for the 'PNswitch8portI67 [PROFINET-Switch, 8-port, IP67]' device. The 'Media redundancy' section is expanded, showing the following settings:

- MRP domain: mrpdomain-1
- Media redundancy role: Client
- Ring port 1: PN-IO [X1]Port 1 [X1 P1 R]
- Ring port 2: PN-IO [X1]Port 2 [X1 P2 R]
- Diagnostics interrupts



If ring wiring is established without the MRP roles being configured for all devices involved, this can result in functional disruptions of the PROFINET network!

4.6 Assign the PROFINET switch a name

When the configuration of the PROFINET switch has been completed in the hardware configurator of the engineering tool, it can be loaded into the PLC.

In order that the PROFINET switch can be found by the PROFINET controller, the PROFINET device name must be assigned to the PROFINET switch. To this purpose, use the function “Assign device name”, which you can access in the Online menu with the right mouse button when the PROFINET switch is activated.

With the “Update list” button, the network can be browsed for PROFINET participants. The PROFINET device name can be assigned to the device with “Assign name”.

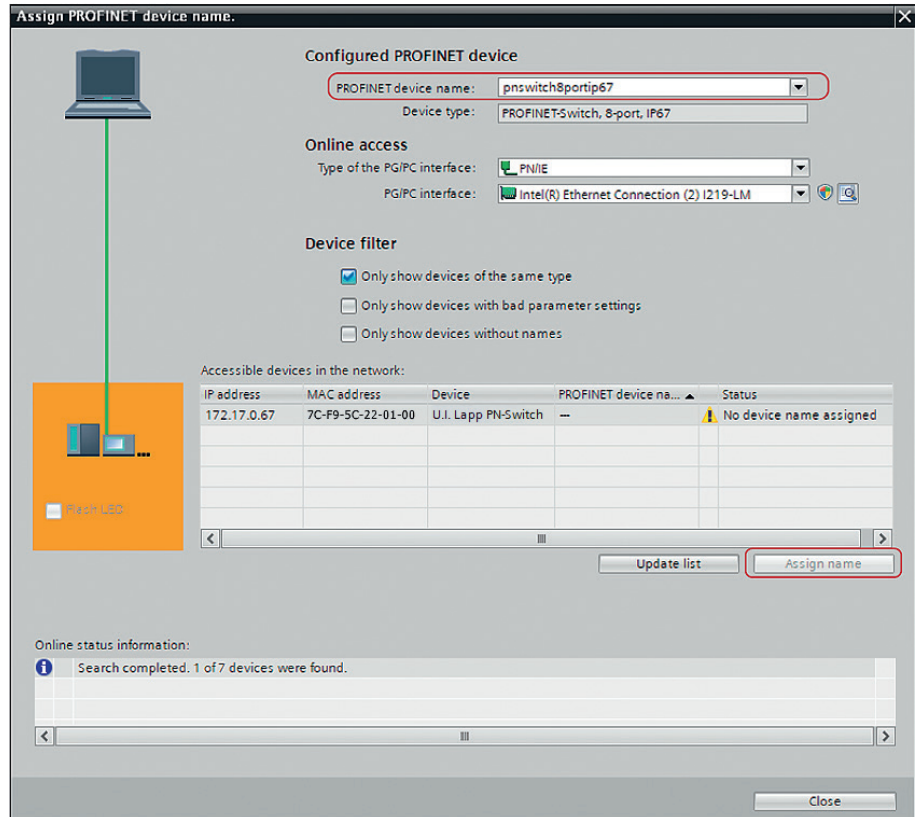

The clear identification of the PROFINET switch is ensured here by the MAC address of the device. The MAC address of the device can be found on the device front of the PROFINET switch.

If the PROFINET switch has been assigned the correct PROFINET name, it is recognized by the PLC and configured. If configuration has taken place correctly, the PROFINET “BF” LED is off.

The IPSet tool, which can be downloaded at no charge from the LAPP website, can also be used to set the PROFINET name.



4.7 Further configuration and diagnosis via the web interface

Via the web interface, the status of the PROFINET switch can be queried and further functions can be configured. Furthermore, a firmware update can be performed via the web interface.

The web interface can be operated as soon as the device has a network configuration. The IP address of the device must be entered as URL.

In the following login dialog the username is „admin“ and the password is the serial number of the PROFINET switch which can be read at the device side. For the first login the default password must be changed.

Further information about the web interface can be taken from the manual.

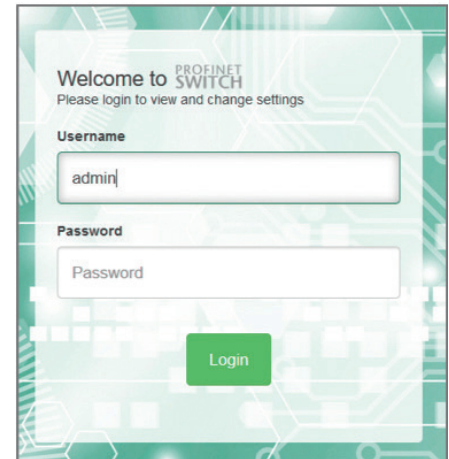

5. Diagnosis via LEDs

RUN	On	Device is ready to operate
	Flashing	Device is starting up
	Flashing synchronous with BF and SF LED	PROFINET function device identification active
BF	On	The device has no configuration and/or there is no connection to the PROFINET controller
	Flashing synchronous with RUN and SF LED	PROFINET function device identification active
SF	On	A PROFINET diagnosis is pending
	Flashing synchronous with RUN and BF LED	PROFINET function device identification active
Ethernet LEDs	Green (Link)	Connected
	Orange (Act)	Data transfer at the port

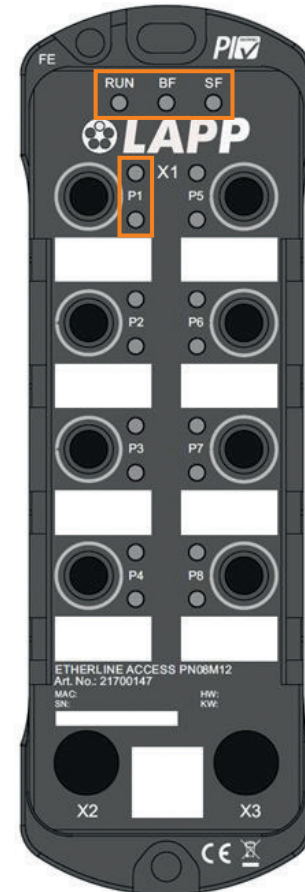

6. Technical data

Order no.	21700147
Name	Etherline® Access PN08 M12
Dimensions (D x W x H)	24 x 62 x 190 mm
Weight	Approx. 410 g
PROFINET interface (X1)	
Protocol	PROFINET IO Device as defined in IEC 61158-6-10
Physical layer	Ethernet
Transmission rate	10/100 Mbit/s, full duplex
Connection	8 x M12 D-coded
Features	PROFINET Conformance Class B; Media Redundancy (MRP); automatic addressing (DCP); topology detection (LLDP); diagnostic alarms
Status indicator	3 LEDs function status, 16 LEDs Ethernet status
Voltage supply (X2)	DC 24 V, 18 – 30 V DC, M12 L-coded
Power consumption	max. 130 mA at 24 V DC
Current draw	Max. 3.5 W
Ambient conditions	
Installation position	Any
Ambient temperature	-40°C ... +75°C
Transport and storage temperature	-40°C ... +85°C
Relative air humidity	95 % r H without condensation
Protection rating	IP67 according to EN 60529
Certifications	CE, PROFINET Conformance Class B
RoHS	Yes
REACH	Yes



NOTE

The contents of this Quick Start Guide have been checked by us so as to ensure that they match the hardware and software described. However, we assume no liability for any existing differences, as these cannot be fully ruled out.

The information in this Quick Start Guide is, however, updated on a regular basis. When using your purchased products, please make sure to use the latest version of this Quick Start Guide, which can be viewed and downloaded on the Internet from www.lappkabel.com/activenetworkcomponents.

Our products contain open source software, among others. This software is subject to the respectively relevant license conditions. We can send you the corresponding license conditions, including a copy of the complete license text together with the product. They are also provided in our download area of the respective products under www.lappkabel.com/activenetworkcomponents.

We also offer to send you or any third party the complete corresponding source text of the respective open source software for an at-cost fee of 10.00 Euro as a DVD upon request. This offer is valid for a period of three years, starting from the date of product delivery.

Our customers are at the center of everything we do. We welcome all ideas and suggestions.

All trademarks shown or mentioned in this document are the property of their respective owners or manufacturers. The representation and naming serve exclusively to explain the use and setting options of the products documented here.

¹⁾ SIMATIC is a registered trademark of Siemens AG.

